



Planning Guide

KONE MonoSpace® 4 DX Core & Pro / 300 & 500 DX
Speed 1.0 - 1.75 m/s
Rated load 320 - 1,150 kg

www.kone.mk

Dedicated to
People Flow™





Configuring your elevator shaft

Configure your elevator to match your unique requirements. Please contact us directly if you have a challenge with the elevator shaft headroom or pit depth of your project. Please be aware what function your elevator is to perform, and contact us for any specialist applications to ensure all requirements are correctly covered.

All dimensions conform with EN 81-20/50 and are in mm unless otherwise stated. All figures shown assume the elevator shaft wall is either concrete, masonry or blockwork with a minimum standard of thickness and strength. All information is for project planning purposes only. Please contact us for verified dimensions for your specific project. Subject to change without notice.

Technical specifications

	MonoSpace® 4 DX Core / MonoSpace 300 DX	MonoSpace® 4 DX Pro / MonoSpace 500 DX
Load (kg)	400*, 450*, 480*, 525*, 630, 800*, 1 000	320*, 400*, 450*, 480*, 525*, 630, 680*, 800*, 900*, 1 000, 1 150*
Speed (m/s)	0.63, 1.0	1.0, 1.6*, 1.75*
Max. floors	14	21 (1 m/s), 24* (1.6 & 1.75 m/s)
Max. travel	40	40 (1 m/s), 75* (1.6 & 1.75 m/s)
Car type	Single and through-type car	Single and through-type car
Car dimensions	Standard	Standard, flexible*
Car height (mm)	2100, 2200	2 100, 2 200, 2 300, 2 400
Door opening	Side	Side, centre
Door duty	Base (KES 202)	Base (KES 100, 202), mid (KES 602), high (KES 800)
Maximum starts / hour	180 / ED 35%	180 / ED 35%
Control system	Down Collective (DC), Full Collective (FC), Down Collective Hybrid with Full Collective (DC-FC), Memory Push Button (MPB)	Down Collective (DC), Full Collective (FC), Down Collective Hybrid with Full Collective (DC-FC), Memory Push Button (MPB), Destination (DCS)
Group size	2	4

* Only available on MonoSpace 300 DX , 500 DX, coming soon on MonoSpace® 4 DX.

Vertical shaft dimensions

Floor to floor distance					
Same side [HF1]				Opposite side [HF2]	
KES 100	KES 202	KES 602	KES 800	v=1 m/s	v=1.6/1.75 m/s
min. HH+450	min. HH+465	min. HH+465	min. HH+600	min. 50 ¹⁾	min. 50 ¹⁾

1) Few options can increase this dimension to min. 300

Speed (m/s)	Minimum travel (m)	Maximum travel (m)	Headroom height [SH] ^{2) 3)}				Pit depth [PH] ⁵⁾	
			Integrated ceiling	Standard ceiling (70 mm thickness)	Suspended ceiling (100 mm thickness)	Suspended ceiling (150 mm thickness)	Without counterweight safety gear	With counterweight safety gear ⁶⁾
0.63 - 1.0	HH + 550	40	CH + 1 220 CH + 500 (EN81-21) ⁴⁾	CH + 1 300 CH + 570 (EN81-21) ⁴⁾	CH + 1 330 CH + 650 (EN81-21) ⁴⁾	CH + 1 380 CH + 650 (EN81-21) ⁴⁾	1 100 650 (EN81-21) ⁴⁾	1 400
1.6 - 1.75	HH + 550	75	CH + 1 420	CH + 1 500	CH + 1 530	CH + 1 580	1 200	1 400

2) Integrated ceiling: RL12

Standard ceiling: CL80, CL80V, CL81, CL82, CL96, CL96V, CL109, CL151, CL182 and CL195

Suspended ceiling (100 mm thickness): CL196

Suspended ceiling (150 mm thickness): CL80FFL and CL96FFL

3) Some configurations require additional 400mm headroom height. These are indicated in the tables on the next pages

4) Please verify your national legislation if any national procedure is in place and prior approval is needed to use EN81-21 dimensions

5) In case of car width below 800mm, minimum pit depth = 1 250. In case of car width below 1 050mm, minimum pit depth = 1 390

6) Mandatory in case of accessible space below the shaft pit

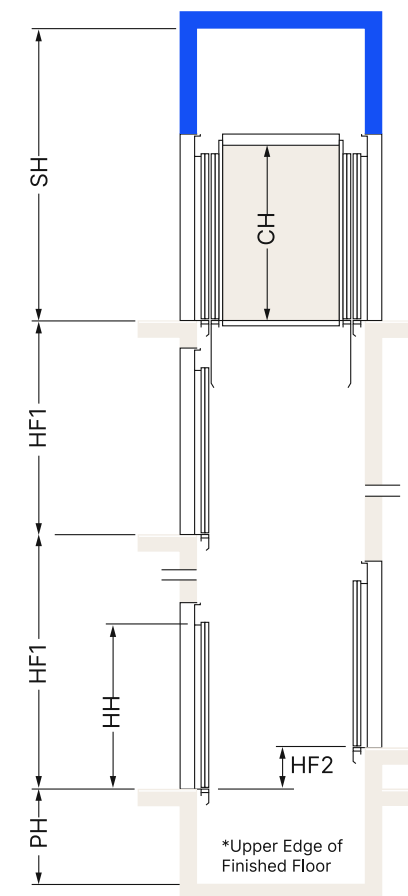

Legend

- CH = Car height
- SH = Headroom height
- PH = Pit height
- HH = Door Height
- HF2 = Floor to floor opposite side
- HF1 = Floor to floor same side

Configuration and dimensions

MonoSpace® 4 DX Core / 300 DX
KES202 Side opening doors

Single entrance car

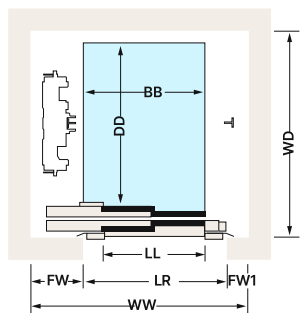

Through-type car

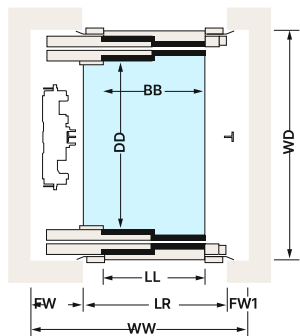

Note:
Elevators with glass doors require larger shaft dimensions.

¹⁾ Not available with front doors.

Accessibility elevators in compliance with EN81-70:2021.

Persons / Rated load [kg]	Car width [BB]	Car depth [DD]	Door width [LL]	Speed m/s	Shaft width [WW]*	Shaft depth [WD]*		Door raw opening width [LR]	Wall projection motor side - frame door [FW]	Wall projection side opposite to motor - frame door [FW1]	Headroom height deviating from p. 2 [SH] With / Without counterweight safety gear
						Single entrance car	Through-type car				
4/400 ¹⁾	850	1200	700	1.0	1320	1535	1730	1000	295	25	- / -
	850	1200	750	1.0	1400	1535	1730	1050	325	25	- / -
5/400	950	1120	700	1.0	1420	1455	1650	1000	270	150	- / -
	950	1120	800	1.0	1450	1455	1650	1100	320	30	- / -
6/450	1000	1200	800	1.0	1470	1550	1730	1100	320	50	- / -
	1000	1200	900	1.0	1600	1550	1730	1200	370	30	+400 / +400
6/480	950	1300	800	1.0	1450	1635	1830	1100	320	30	- / -
	950	1300	900	1.0	1600	1635	1830	1200	370	30	+400 / +400
	1000	1300	800	1.0	1470	1635	1830	1100	320	50	- / -
	1000	1300	900	1.0	1600	1635	1830	1200	370	30	+400 / +400
	1000	1250	800	1.0	1470	1600	1780	1100	320	50	- / -
	1000	1250	900	1.0	1600	1600	1780	1200	370	30	+400 / +400
7/525	1050	1250	800	1.0	1520	1600	1780	1100	320	100	- / -
	1050	1250	900	1.0	1600	1600	1780	1200	370	30	- / +400
	1050	1300	800	1.0	1520	1635	1830	1100	320	100	- / -
	1050	1300	900	1.0	1600	1635	1830	1200	370	30	- / +400
8/630	1100	1400	800	1.0	1570	1750	1930	1100	320	150	- / -
8/630 ²⁾	1100	1400	900	1.0	1600	1750	1930	1200	370	30	- / -
10/800	1200	1500	800	1.0	1720	1835	2030	1100	370	230	- / -
10/800 ²⁾	1200	1500	900	1.0	1720	1835	2030	1200	370	130	- / -
13/1,000	1100	2100	800	1.0	1600	2435	2630	1100	350	150	- / +400
13/1,000 ²⁾	1100	2100	900	1.0	1600	2435	2630	1200	370	30	- / -
	1100	2100	1000	1.0	1750	2435	2630	1300	420	30	+400 / +400
	1400	1600	900	1.0	1900	1950	2130	1200	450	250	- / +400
	1400	1600	1000	1.0	1900	1950	2130	1300	450	150	- / +400

All dimensions are in mm unless otherwise stated. Shaft dimensions include +/- 25mm horizontal tolerance over total shaft height. All information is for project planning purposes only. Subject to change without notice.

We will be happy to advise you personally on your plans. You can either contact your consultant directly or complete the form on our website.

Configuration and dimensions

MonoSpace® 4 DX Pro / 500 DX
KES202 / KES602 Side opening doors

Single entrance car

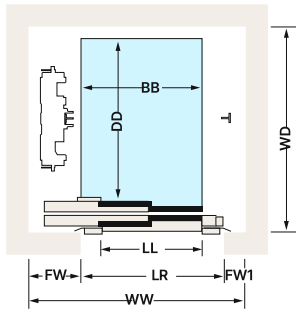

Through-type car

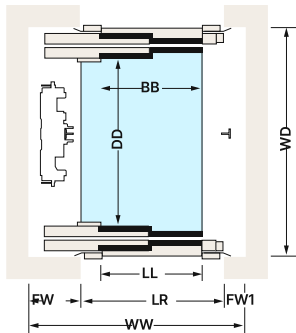

Note:
Elevators with glass doors require larger shaft dimensions.

¹⁾ Not available with front doors.

Accessibility elevators in compliance with EN81-70:2021.

We will be happy to advise you personally on your plans. You can either contact your consultant directly or complete the form on our website.

Persons / Rated load [kg]	Car width [BB]	Car depth [DD]	Door width [LL]	Speed [m/s]	Shaft width [WW]	Shaft depth [WD]		Door raw opening width [LR]	Wall projection motor side - frame door [FW]	Wall projection side opposite to motor - frame door [FW1]	Headroom height deviating from p. 2 [SH] With / Without counterweight safety gear
						Single entrance car	Through-type car				
4/400	800	1200	700	1.0	1300	1535	1730	1000	270	30	- / -
5/400	950	1100	700	1.0/1.6/1.75	1420	1435	1630	1000	270	150	- / -
	950	1100	800	1.0/1.6/1.75	1450	1435	1630	1100	320	30	- / -
6/450	1000	1200	800	1.0/1.6/1.75	1470	1550	1730	1100	320	50	- / -
	1000	1200	900	1.0/1.6/1.75	1600	1550	1730	1200	370	30	+400 / +400
6/480	950	1300	700	1.0/1.6/1.75	1420	1635	1830	1000	270	150	- / -
	950	1300	800	1.0/1.6/1.75	1450	1635	1830	1100	320	30	- / -
	950	1300	900	1.0/1.6/1.75	1600	1635	1830	1200	370	30	+400 / +400
	1000	1300	800	1.0/1.6/1.75	1470	1635	1830	1100	320	50	- / -
	1000	1300	900	1.0/1.6/1.75	1600	1635	1830	1200	370	30	+400 / +400
	1000	1250	800	1.0/1.6/1.75	1470	1600	1780	1100	320	50	- / -
	1000	1250	900	1.0/1.6/1.75	1600	1600	1780	1200	370	30	+400 / +400
	1000	1250	900	1.0/1.6/1.75	1600	1600	1780	1200	370	30	+400 / +400
7/525	1050	1250	800	1.0/1.6/1.75	1520	1600	1780	1100	320	100	- / -
	1050	1250	900	1.0/1.6/1.75	1600	1600	1780	1200	370	30	- / +400
	1050	1300	800	1.0/1.6/1.75	1520	1635	1830	1100	320	100	- / -
	1050	1300	900	1.0/1.6/1.75	1600	1635	1830	1200	370	30	- / +400
8/630	1100	1400	800	1.0/1.6/1.75	1570	1750	1930	1100	320	150	- / -
8/630 ¹⁾	1100	1400	900	1.0/1.6/1.75	1600	1750	1930	1200	370	30	- / -
9/680 ¹⁾	1130	1400	900	1.0/1.6/1.75	1600	1750	1930	1200	370	30	- / -
	1130	1400	1000	1.0/1.6/1.75	1750	1750	1930	1300	420	30	+400 / +400
	1200	1400	900	1.0/1.6/1.75	1670	1750	1930	1200	420	50	- / -
10/800 ¹⁾	1350	1400	800	1.0/1.6/1.75	1850	1750	1930	1100	500	250	- / +400
10/800 ¹⁾	1350	1400	900	1.0/1.6/1.75	1850	1750	1930	1200	500	150	- / +400
	1350	1400	1000	1.0/1.6/1.75	1850	1750	1930	1300	500	50	- / +400
12/900 ¹⁾	1400	1500	900	1.0/1.6/1.75	1900	1835	2030	1200	450	250	- / +400
	1400	1500	1000	1.0/1.6/1.75	1900	1835	2030	1300	450	150	- / +400
13/1,000	1100	2100	800	1.0/1.6/1.75	1600	2435	2630	1100	350	150	- / +400
13/1,000 ¹⁾	1100	2100	900	1.0/1.6/1.75	1600	2435	2630	1200	370	30	- / -
	1100	2100	1000	1.0/1.6/1.75	1750	2435	2630	1300	420	30	+400 / +400
	1300	1700	900	1.0/1.6/1.75	1800	2035	2230	1200	450	150	- / +400
	1300	1700	1000	1.0/1.6/1.75	1800	2035	2230	1300	450	50	- / +400
	1400	1600	900	1.0/1.6/1.75	1900	1950	2130	1200	450	250	- / +400
	1400	1600	1000	1.0/1.6/1.75	1900	1950	2130	1300	450	150	- / +400
	1450	1550	900	1.0/1.6/1.75	1950	1885	2080	1200	500	250	- / +400
15/1,150 ¹⁾	1450	1550	1000	1.0/1.6/1.75	1950	1885	2080	1300	500	150	- / +400
	1200	2100	900	1.0/1.6/1.75	1700	2435	2630	1200	450	50	- / +400
	1200	2100	1000	1.0/1.6/1.75	1750	2435	2630	1300	420	30	- / +400
	1200	2100	1100	1.0/1.6/1.75	1900	2435	2630	1400	470	30	+400 / +400
	1400	1850	900	1.0/1.6/1.75	1900	2185	2380	1200	450	250	- / +400
	1400	1850	1000	1.0/1.6/1.75	1900	2185	2380	1300	450	150	- / +400
	1400	1850	1100	1.0/1.6/1.75	1900	2185	2380	1400	470	30	- / -

Configuration and dimensions

MonoSpace® 4 DX Pro / 500 DX
KES202 / KES602 Centre opening

Single entrance car

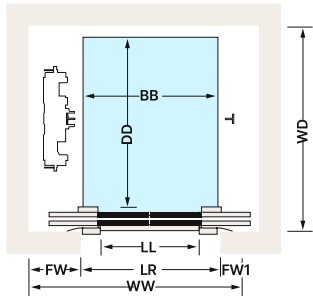

Through-type car

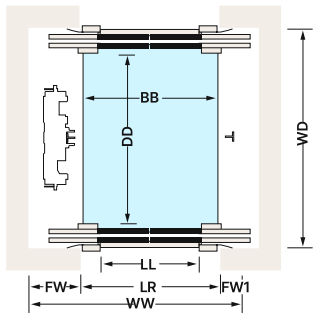

Note:
Elevators with glass doors require larger shaft dimensions.

¹⁾ Not available with front doors.

Accessibility elevators in compliance with EN81-70:2021.

Persons / Rated load [kg]	Car width [BB]	Car depth [DD]	Door width [LL]	Speed [m/s]	Shaft width [WW]	Shaft depth [WD]		Door raw opening width [LR]	Wall projection motor side - frame door [FW]	Wall projection side opposite to motor - frame door [FW1]	Headroom height deviating from p. 2 [SH] With / Without counterweight safety gear
						Single entrance car	Through-type car				
8/630 ¹⁾	1 100	1 400	800	1.0/1.6/1.75	1 740	1 690	1 810	1 100	320	320	- / -
8/630	1 100	1 400	900	1.0/1.6/1.75	1 940	1 690	1 810	1 200	370	370	+400 / +400
	1 100	1 400	1000	1.0/1.6/1.75	2 140	1 690	1 810	1 300	420	420	+400 / +400
10/800 ¹⁾	1 350	1 400	800	1.0/1.6/1.75	1 840	1 690	1 810	1 100	370	370	- / -
10/800	1 350	1 400	900	1.0/1.6/1.75	1 940	1 690	1 810	1 200	370	370	- / -
12/900	1 400	1 500	800	1.0/1.6/1.75	1 900	1 775	1 910	1 100	400	400	- / -
12/900	1 400	1 500	900	1.0/1.6/1.75	1 940	1 775	1 910	1 200	370	370	- / -
13/1,000	1 100	2 100	900	1.0/1.6/1.75	1 940	2 375	2 510	1 200	370	370	+400 / +400
	1 100	2 100	1 000	1.0/1.6/1.75	2 140	2 375	2 510	1 300	420	420	+400 / +400
	1 300	1 700	900	1.0/1.6/1.75	1 940	1 975	2 110	1 200	370	370	- / -
	1 300	1 700	1 000	1.0/1.6/1.75	2 140	1 975	2 110	1 300	420	420	+400 / +400
	1 300	1 700	1 100	1.0/1.6/1.75	2 340	1 975	2 110	1 400	470	470	+400 / +400
	1 400	1 600	1 000	1.0/1.6/1.75	2 140	1 890	2 010	1 300	420	420	+400 / +400
	1 400	1 600	1 100	1.0/1.6/1.75	2 340	1 890	2 010	1 400	470	470	+400 / +400
	1 450	1 550	900	1.0/1.6/1.75	1 940	1 835	1 960	1 200	370	370	- / -
15/1,150	1 450	1 550	1 000	1.0/1.6/1.75	2 140	1 835	1 960	1 300	420	420	- / -
	1 600	1 400	900	1.0/1.6/1.75	2 100	1 690	1 810	1 200	450	450	- / -
	1 600	1 400	1 000	1.0/1.6/1.75	2 140	1 690	1 810	1 300	420	420	- / -
	1 600	1 400	1 100	1.0/1.6/1.75	2 340	1 690	1 810	1 400	470	470	+400 / +400
	1 200	2 100	900	1.0/1.6/1.75	1 940	2 375	2 510	1 200	370	370	+400 / +400
	1 200	2 100	1 000	1.0/1.6/1.75	2 140	2 375	2 510	1 300	420	420	+400 / +400
	1 200	2 100	1 100	1.0/1.6/1.75	2 340	2 375	2 510	1 400	470	470	+400 / +400
	1 400	1 850	900	1.0/1.6/1.75	1 940	2 125	2 260	1 200	370	370	- / -
1 400	1 850	1 000	1.0/1.6/1.75	2 140	2 125	2 260	1 300	420	420	+400 / +400	
		1 100	1.0/1.6/1.75	2 340	2 125	2 260	1 400	470	470	+400 / +400	

We will be happy to advise you personally on your plans. You can either contact your consultant directly or complete the form on our website.

Configuration and dimensions

MonoSpace® 4 DX Pro / 500 DX KES800* Side opening doors

* Not available with front doors

Single entrance car

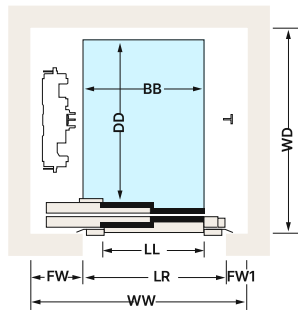

Through-type car

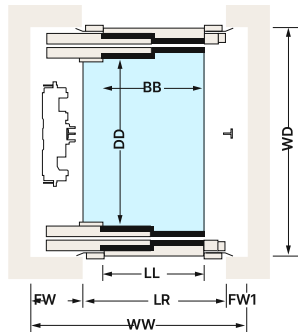

♿ Accessibility elevators in compliance with EN81-70:2021.

We will be happy to advise you personally on your plans. You can either contact your consultant directly or complete the form on our website.

Persons / Rated load [kg]	Car width [BB]	Car depth [DD]	Door width [LL]	Speed [m/s]	Shaft width [WW]	Shaft depth [WD]		Door raw opening width [LR]	Wall projection motor side - frame door [FW]	Wall projection side opposite to motor - frame door [FW1]	Headroom height deviating from p. 2 [SH] With / Without counterweight safety gear
						Single entrance car	Through-type car				
4/400	800	1200	700	1	1300	1575	1810	1000	270	30	- / -
5/400	950	1100	700	1.0/1.6/1.75	1420	1475	1710	1000	270	150	- / -
	950	1100	800	1.0/1.6/1.75	1450	1475	1710	1100	320	30	- / -
6/450	1000	1200	800	1.0/1.6/1.75	1470	1575	1810	1100	320	50	- / -
	1000	1200	900	1.0/1.6/1.75	1600	1575	1810	1200	370	30	+400 / +400
6/480	950	1300	700	1.0/1.6/1.75	1420	1675	1910	1000	270	150	- / -
	950	1300	800	1.0/1.6/1.75	1450	1675	1910	1100	320	30	- / -
	950	1300	900	1.0/1.6/1.75	1600	1675	1910	1200	370	30	+400 / +400
	1000	1300	800	1.0/1.6/1.75	1470	1675	1910	1100	320	50	- / -
	1000	1300	900	1.0/1.6/1.75	1600	1675	1910	1200	370	30	+400 / +400
	1000	1250	800	1.0/1.6/1.75	1470	1640	1860	1100	320	50	- / -
7/525	1050	1250	800	1.0/1.6/1.75	1520	1640	1860	1100	320	100	- / -
	1050	1250	900	1.0/1.6/1.75	1600	1640	1860	1200	370	30	- / +400
8/630	1100	1400	800	1.0/1.6/1.75	1570	1790	2010	1100	320	150	- / -
	1100	1400	900	1.0/1.6/1.75	1600	1790	2010	1200	370	30	- / -
9/680 ♿	1130	1400	900	1.0/1.6/1.75	1600	1790	2010	1200	370	30	- / -
	1130	1400	1000	1.0/1.6/1.75	1750	1790	2010	1300	420	30	+400 / +400
	1200	1400	900	1.0/1.6/1.75	1670	1790	2010	1200	420	50	- / -
10/800	1350	1400	800	1.0/1.6/1.75	1850	1790	2010	1100	500	250	- / +400
10/800 ♿	1350	1400	900	1.0/1.6/1.75	1850	1790	2010	1200	500	150	- / +400
	1350	1400	1000	1.0/1.6/1.75	1850	1790	2010	1300	500	50	- / +400
12/900 ♿	1400	1500	900	1.0/1.6/1.75	1900	1875	2110	1200	450	250	- / +400
	1400	1500	1000	1.0/1.6/1.75	1900	1875	2110	1300	450	150	- / +400
13/1,000	1100	2100	800	1.0/1.6/1.75	1600	2475	2710	1100	350	150	- / +400
13/1,000 ♿	1100	2100	900	1.0/1.6/1.75	1650	2475	2710	1200	370	30	- / -
	1100	2100	1000	1.0/1.6/1.75	1750	2475	2710	1300	420	30	+400 / +400
	1300	1700	900	1.0/1.6/1.75	1800	2075	2310	1200	450	150	- / +400
	1300	1700	1000	1.0/1.6/1.75	1800	2075	2310	1300	450	50	- / +400
	1400	1600	900	1.0/1.6/1.75	1900	1990	2210	450	250	1200	- / +400
	1400	1600	1000	1.0/1.6/1.75	1900	1990	2210	450	150	1300	- / +400
	1450	1550	900	1.0/1.6/1.75	1950	1925	2160	500	250	1200	- / +400
15/1,150 ♿	1450	1550	1000	1.0/1.6/1.75	1950	1925	2160	500	150	1300	- / +400
	1200	2100	900	1.0/1.6/1.75	1700	2475	2710	1200	450	50	- / +400
	1200	2100	1000	1.0/1.6/1.75	1750	2475	2710	1300	420	30	- / +400
	1200	2100	1100	1.0/1.6/1.75	1900	2475	2710	1400	470	30	+400 / +400
	1400	1850	900	1.0/1.6/1.75	1900	2225	2460	1200	450	250	- / +400
	1400	1850	1000	1.0/1.6/1.75	1900	2225	2460	1300	450	150	- / +400
	1400	1850	1100	1.0/1.6/1.75	1900	2225	2460	1400	470	30	- / -

All dimensions are in mm unless otherwise stated. Shaft dimensions include +/- 25mm horizontal tolerance over total shaft height. All information is for project planning purposes only. Subject to change without notice.

Configuration and dimensions

MonoSpace® 4 DX Pro / 500 DX KES800* Centre opening doors

* Not available with front doors

Single entrance car

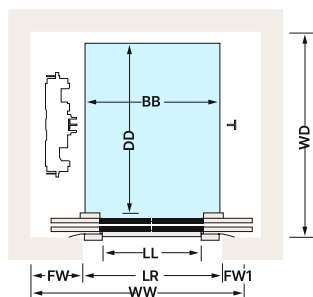

Through-type car

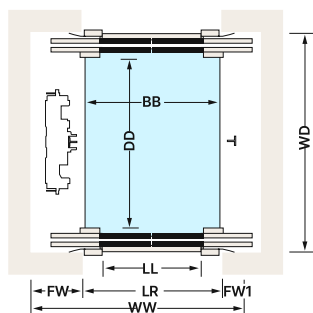

Persons / Rated load [kg]	Car width [BB]	Car depth [DD]	Door width [LL]	Speed [m/s]	Shaft width [WW]	Shaft depth [WD]		Door raw opening width [LR]	Wall projection motor side - frame door [FW]	Wall projection side opposite to motor - frame door [FW1]	Headroom height deviating from p. 2 [SH] With / Without counterweight safety gear
						Single entrance car	Through-type car				
8/630	1 100	1 400	800	1.0/1.6/1.75	1 740	1 690	1 810	1 100	325	325	- / -
8/630 ♿	1 100	1 400	900	1.0/1.6/1.75	1 940	1 690	1 810	1 200	375	375	+400 / +400
	1 100	1 400	1 000	1.0/1.6/1.75	2 140	1 690	1 810	1 300	425	425	+400 / +400
10/800	1 350	1 400	800	1.0/1.6/1.75	1 840	1 690	1 810	1 100	370	370	- / -
10/800 ♿	1 350	1 400	900	1.0/1.6/1.75	1 940	1 690	1 810	1 200	375	375	- / -
12/900	1 400	1 500	800	1.0/1.6/1.75	1 900	1 775	1 910	1 100	390	410	- / -
12/900 ♿	1 400	1 500	900	1.0/1.6/1.75	1 940	1 775	1 910	1 200	375	375	- / -
13/1,000 ♿	1 100	2 100	900	1.0/1.6/1.75	1 940	2 375	2 510	1 200	375	375	+400 / +400
	1 100	2 100	1 000	1.0/1.6/1.75	2 140	2 375	2 510	1 300	425	425	+400 / +400
	1 300	1 700	900	1.0/1.6/1.75	1 940	1 975	2 110	1 200	375	375	- / -
	1 300	1 700	1 000	1.0/1.6/1.75	2 140	1 975	2 110	1 300	425	425	+400 / +400
	1 300	1 700	1 100	1.0/1.6/1.75	2 340	1 975	2 110	1 400	475	475	+400 / +400
	1 400	1 600	1 000	1.0/1.6/1.75	2 140	1 890	2 010	1 300	425	425	+400 / +400
	1 400	1 600	1 100	1.0/1.6/1.75	2 340	1 890	2 010	1 400	475	475	+400 / +400
	1 450	1 550	900	1.0/1.6/1.75	1 940	1 835	1 960	1 200	375	375	- / -
	1 450	1 550	1 000	1.0/1.6/1.75	2 140	1 835	1 960	1 300	425	425	- / -
	1 600	1 400	900	1.0/1.6/1.75	2 100	1 690	1 810	1 200	450	450	- / -
15/1,150 ♿	1 600	1 400	1 000	1.0/1.6/1.75	2 140	1 690	1 810	1 300	425	425	- / -
	1 600	1 400	1 100	1.0/1.6/1.75	2 340	1 690	1 810	1 400	475	475	+400 / +400
	1 200	2 100	900	1.0/1.6/1.75	1 940	2 375	2 510	1 200	375	375	+400 / +400
	1 200	2 100	1 000	1.0/1.6/1.75	2 140	2 375	2 510	1 300	425	425	+400 / +400
	1 200	2 100	1 100	1.0/1.6/1.75	2 340	2 375	2 510	1 400	475	475	+400 / +400
	1 400	1 850	900	1.0/1.6/1.75	1 940	2 125	2 260	1 200	375	375	- / -
	1 400	1 850	1 000	1.0/1.6/1.75	2 140	2 125	2 260	1 300	425	425	+400 / +400
	1 400	1 850	1 100	1.0/1.6/1.75	2 340	2 125	2 260	1 400	475	475	+400 / +400

All dimensions are in mm unless otherwise stated. Shaft dimensions include +/- 25mm horizontal tolerance over total shaft height. All information is for project planning purposes only. Subject to change without notice.

♿ Accessibility elevators in compliance with EN81-70:2021.

We will be happy to advise you personally on your plans. You can either contact your consultant directly or complete the form on our website.

Door types and maintenance panel

The selection of elevator doors plays a crucial role in both performance and aesthetics. We provide door systems tailored to various needs and preferences.

This planning guide includes shaft dimensions for the most common car dimensions with KES 202, KES 602 and KES 800. If you have specific car dimensions in mind for your project, feel free to contact us.

Door type	Door duty
KES 100	Up to 200,000 starts per year, suitable for narrow shafts
KES 202	Up to 200,000 starts per year
KES 602	Up to 400,000 starts per year
KES 800	Up to 800,000 starts per year

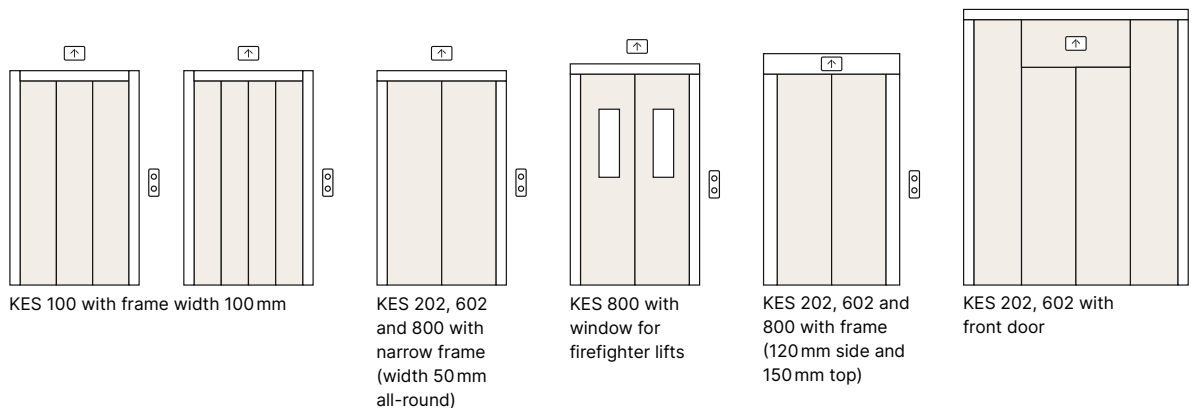

Technical specifications	
Door opening	Side / Centre opening
Door height [mm]	2 000, 2 100, 2 200, 2 300
Door width [mm]	600, 700, 800, 900, 1 000, 1 100
Fire resistance range EN 81-58	E120, EW60, EI30, EI60, EI120
Door recess	Up to 80 mm for reduced shaft depth (side opening doors only)
Door opening height [HR] (mm)	Narrow frame: HH+80 Frame: HH+180 Front: up to 3 000

Wall-mounted maintenance panel

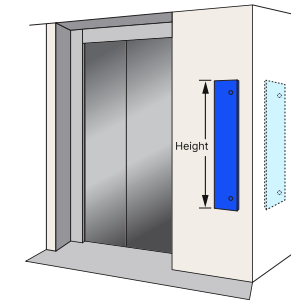

Door-mounted maintenance panel

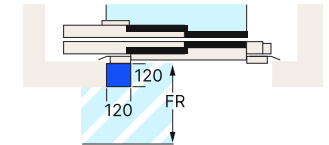
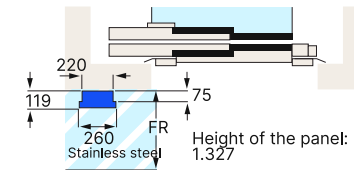
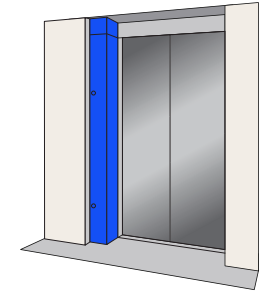

Technical specifications

- Placement in the topmost floor. Option: Can be moved up to 18 m below the topmost floor
- Always located on the motor side
- Minimum 700 mm required for maintenance and 1 200 mm in public use areas
- Door-mounted panel only available for front door and frame door with minimum 120 mm width
- Wall-mounted panel also available on the side wall of the shaft

Consult your local KONE sales representative. We will be happy to advise you personally. All dimensions are in mm unless otherwise stated. All information is for project planning purposes only. Subject to change without notice.

Successful planning with KONE

Whether your project involves a new build, conversion, modernization or operation, you can be assured of success with us as your partners. We not only advise you on finding and implementing solutions, but also help you with our expert knowledge of standards, safety and sustainability, as well as future-proofing.

Planning

SUSTAINABLE · FUTURE-PROOF · INDIVIDUAL

We can work with you to analyse the building requirements and your needs in order to find the best possible solution. We consider standards & regulations, energy efficiency, technology, digitalisation, comfort and your ideas regarding design and equipment.

Construction

SAFETY · TIME · COST

Our certified processes and quality criteria at every stage of installation mean you can rest assured of the compliance of your plans. Our unique installation method inside the shaft saves time and money and reduces the need to coordinate with other tradespeople.

Operation

AVAILABILITY · ACCESSIBILITY · EXPERTISE

We can assist with the commissioning and operation of the systems. Our services are modular in structure and can be used digitally. We guarantee availability and safety and can be reached 24 hours a day / 365 days a year.

KONE Studio



Get all the technical data you need in one easy-to-use tool, including downloadable CAD and BIM models, as well as detailed elevator specifications.





KONE provides innovative and eco-efficient solutions for elevators, escalators, automatic building doors and the systems that integrate them with today's intelligent buildings. We support our customers every step of the way: from design, manufacturing and installation to maintenance and modernization.

KONE is a global leader in managing the smooth flow of people and goods throughout buildings. This makes us a reliable partner throughout the life cycle of buildings. We are fast, flexible, and we have a well-deserved reputation as a technology leader, with such innovations as KONE 24/7 Connected Services and KONE UltraRope®.

KONE employs over 63,000 dedicated experts to serve you globally and locally.

KONE MACEDONIA

Corporate offices

Filip Vtori Makedonski 3
Soravia Centar, 7-i kat
1000, Skopje
North Macedonia

Tel: +381 11 3591 230
ksb.info@kone.com

www.kone.mk

This publication is for general informational purposes only and we reserve the right at any time to alter the product design and specifications. No statement this publication contains shall be construed as a warranty or condition, express or implied, as to any product, its fitness for any particular purpose, merchantability, quality or representation of the terms of any purchase agreement. Minor differences between printed and actual colors may exist. KONE MonoSpace® DX, KONE EcoDisc® and People Flow® are registered trademarks of KONE Corporation. Copyright © 2025 KONE Corporation.